

21 21 24 50 769

Advanced Performance 28 1SS Cooler Office

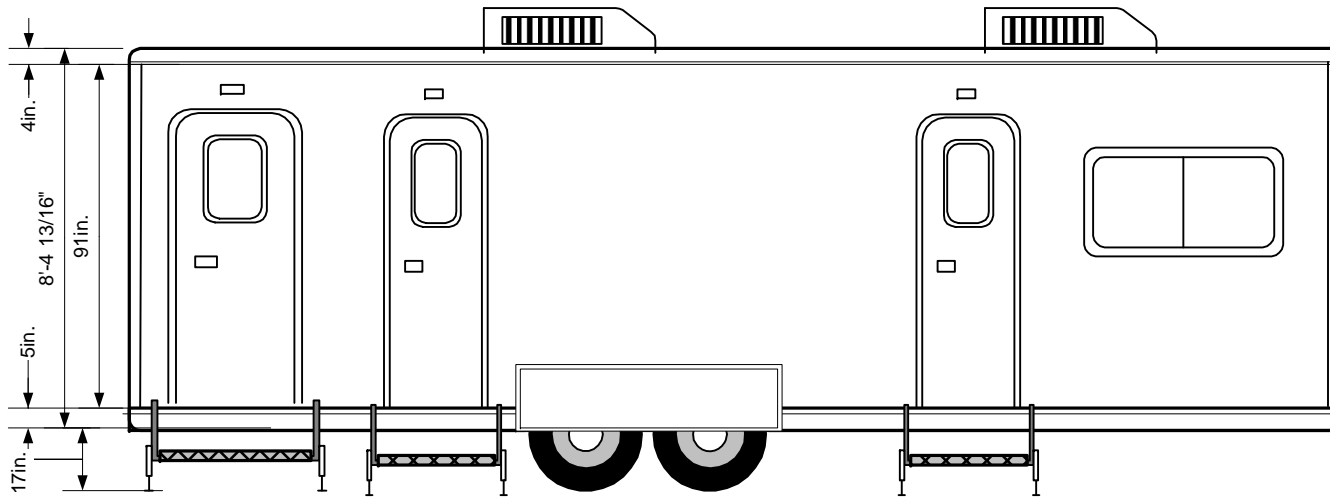

- All metal and composite construction
- 3 step landings & 4 leveling jacks
- 2 7000 pound axles with electric brakes
- Air Conditioned 30,000 BTU heat 11000
- (1) 240 v @ 50 amp AC power required
- 375 gallon water tank capacity
- 250 gallon fuel storage
- LED 50,000 hour burn lighting
- Radiused skylight doors and auto closers
- 2 cooling benches over tires
- 1 ANSI Drench shower & eyewash
- Gold Stainless Steel pump
- Constantly stirred temperature controlled water tanks
- Generator platform & 2' x 4' window

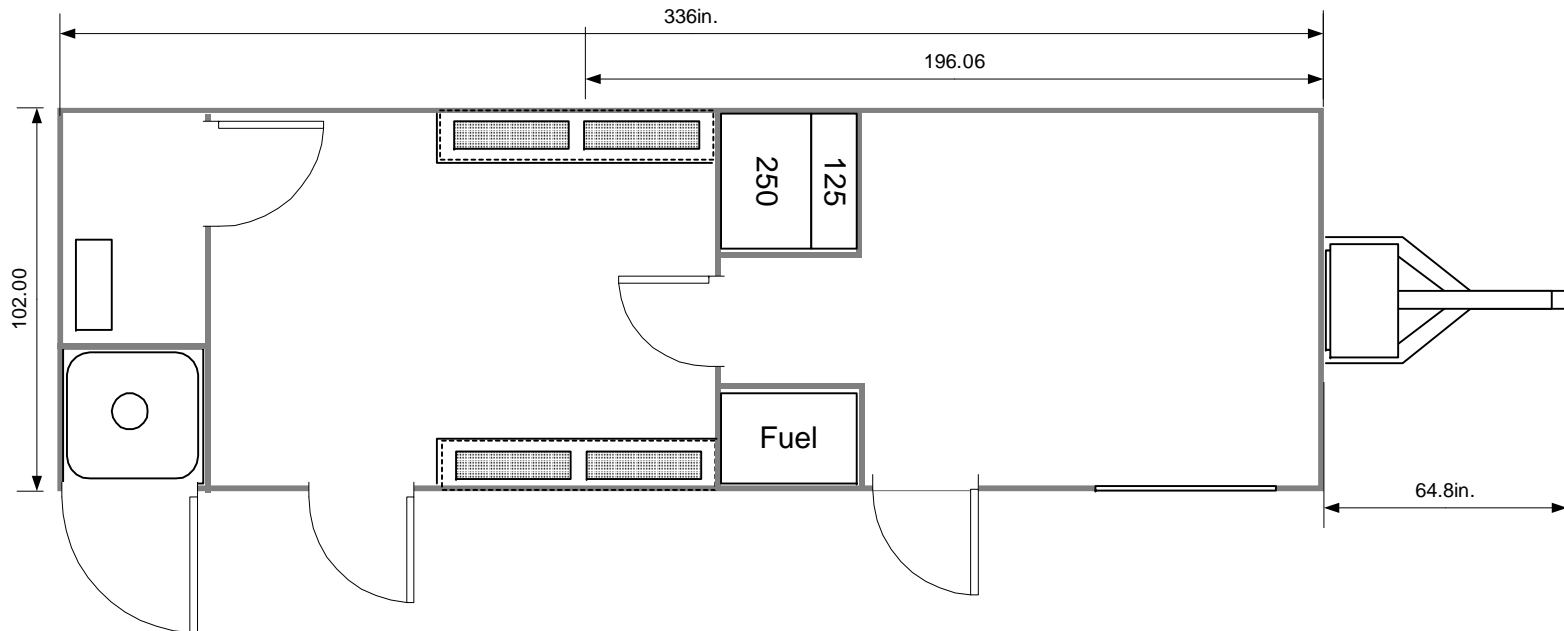

This document is the property of and contains unpublished proprietary information and trade secrets of A.M.S. Global Inc. By accepting possession of the document the recipient agrees to make no copies transcriptions or any use of this document or the information contained herein except as authorized by A.M.S. Global Inc. and further agrees to safe keep this document and return in to A.M.S. Global Inc. upon demand.

Approved by _____

www.AMSglobal.us (877) 789-1213 Copyright 2011 A.M.S. Global Inc. All rights reserved



250914490334

Advanced Performance 28 2S1T2S 20LC + Office

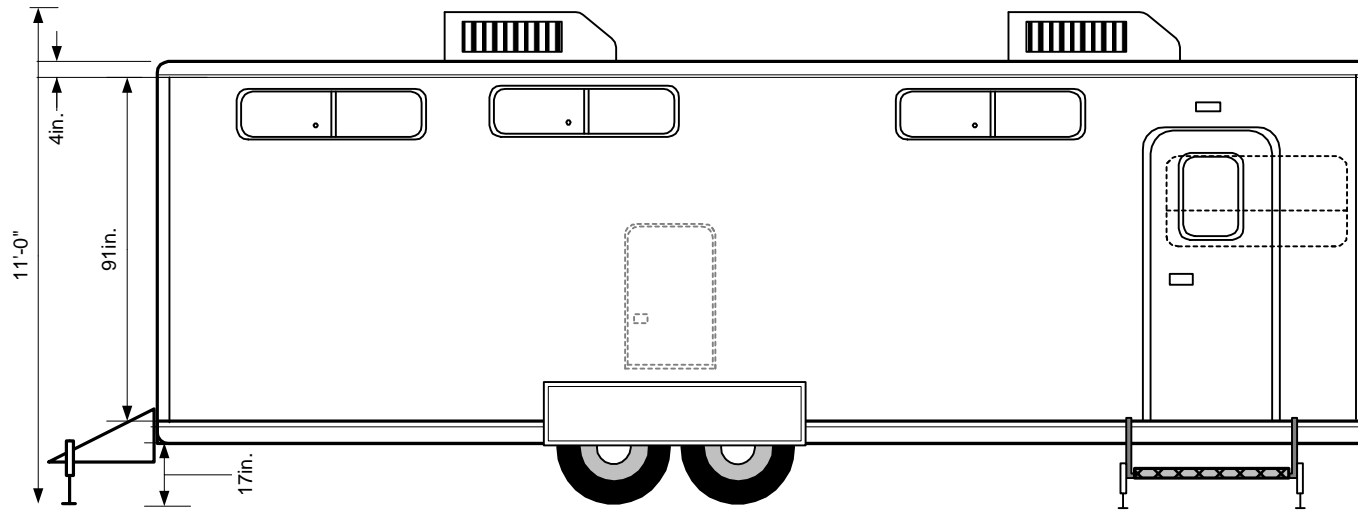

- 40 15x12x36 Lockers or 20 15x12x72
- 2 one step landings with Led porch lights
- Leveling jacks and five windows
- 2 7000 pound axles with electric brakes
- Air Conditioned 30,000 BTU heat 1/4000Vh
- (1) 240 v @ 50 amp AC power required
- Heat on demand metered showers (2)
- All metal and composite construction no wood
- 1 Toilets 2 wall sinks
- Direct connect to sewer
- LED 10,000 hour burn lighting
- Radiused skylight doors and auto closers
- Retractable tounge & Low profile
- 3 benches

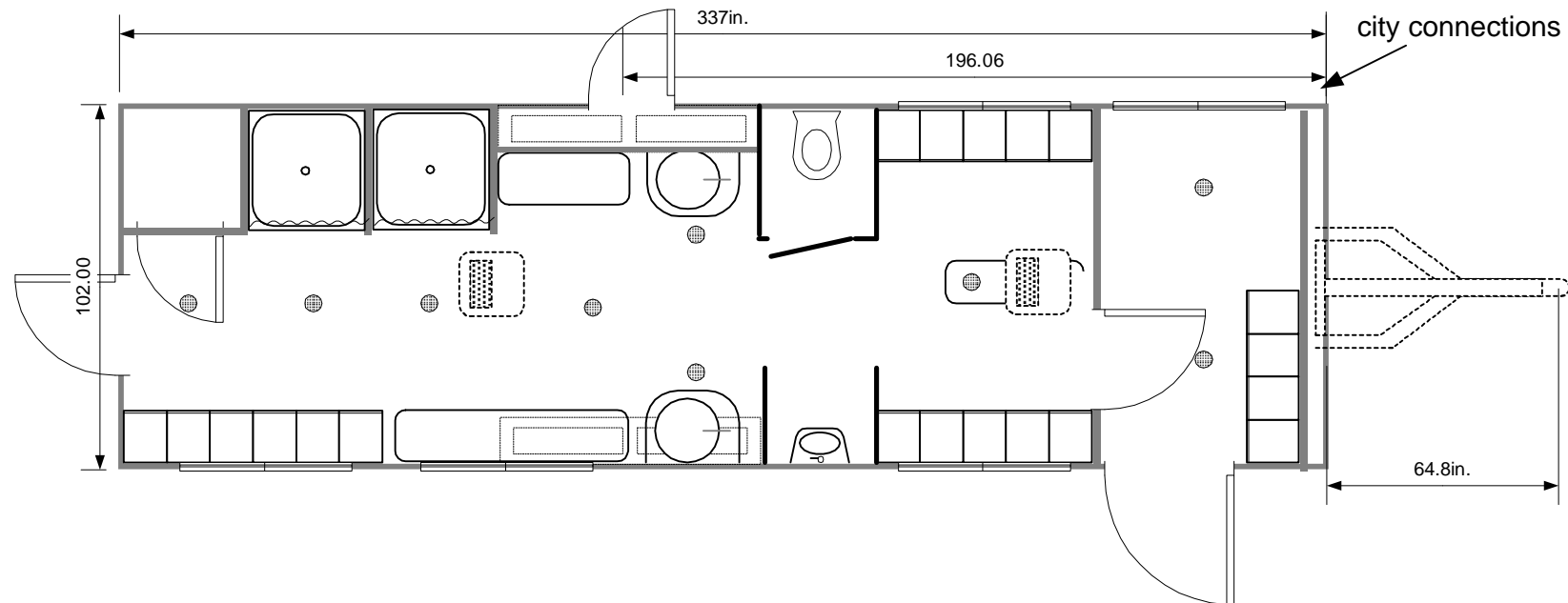

This document is the property of and contains unpublished proprietary information and trade secrets of A.M.S. Global Inc. By accepting possession of the document the recipient agrees to make no copies transcriptions or any use of this document or the information contained herein except as authorized by A.M.S. Global Inc. and further agrees to safe keep this document and return in to A.M.S. Global Inc. upon demand.

Approved by _____

www.AMSglobal.us (877) 789-1213 Copyright 2011 A.M.S. Global Inc. All rights reserved



250914490334

Advanced Performance 28 2S1T2S 20LC + Office Advanced Performance 24 2S1T2S 16LC

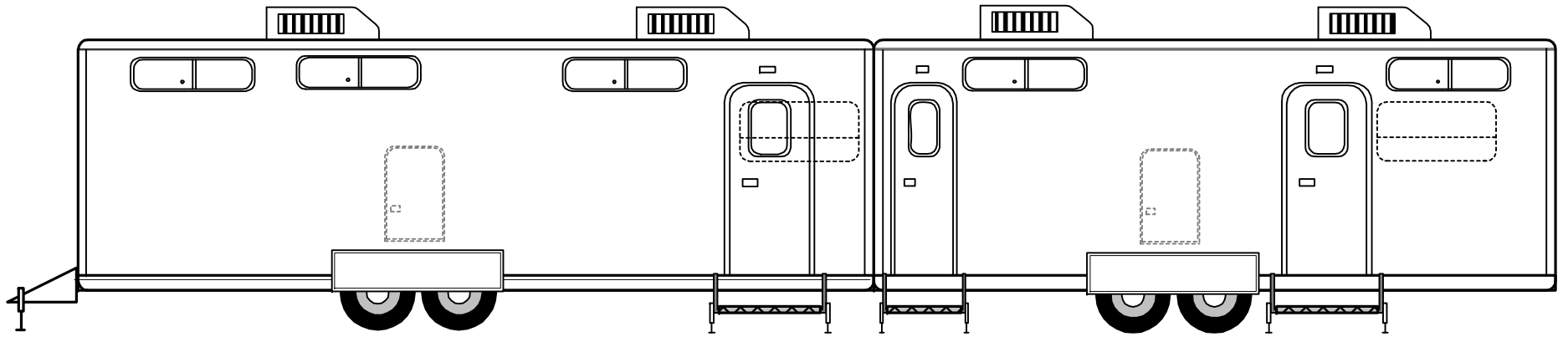

52'

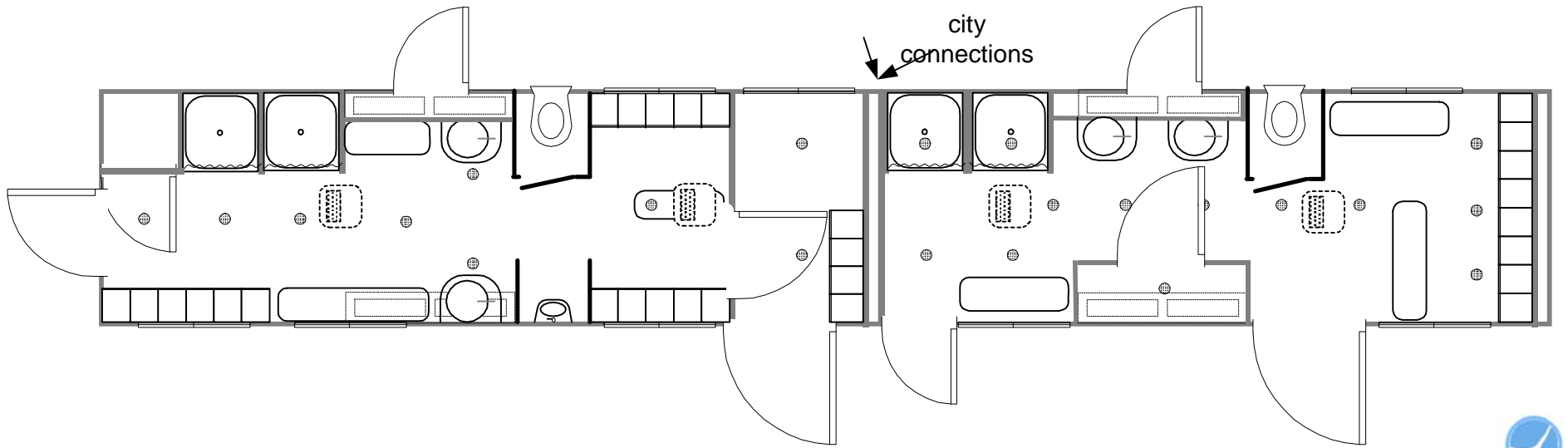

This document is the property of and contains unpublished proprietary information and trade secrets of A.M.S. Global Inc. By accepting possession of this document the recipient agrees to make no copies, transcriptions or any use of this document or the information contained herein except as authorized by A.M.S. Global Inc. and further agrees to safe keep this document and return it to A.M.S. Global Inc. upon demand.

Approved by _____

www.AMSglobal.us (877) 789-1213 Copyright 2011 A.M.S. Global Inc. All rights reserved

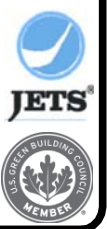

250914490334

Advanced Performance 28 2S1T2S 20LC + Office

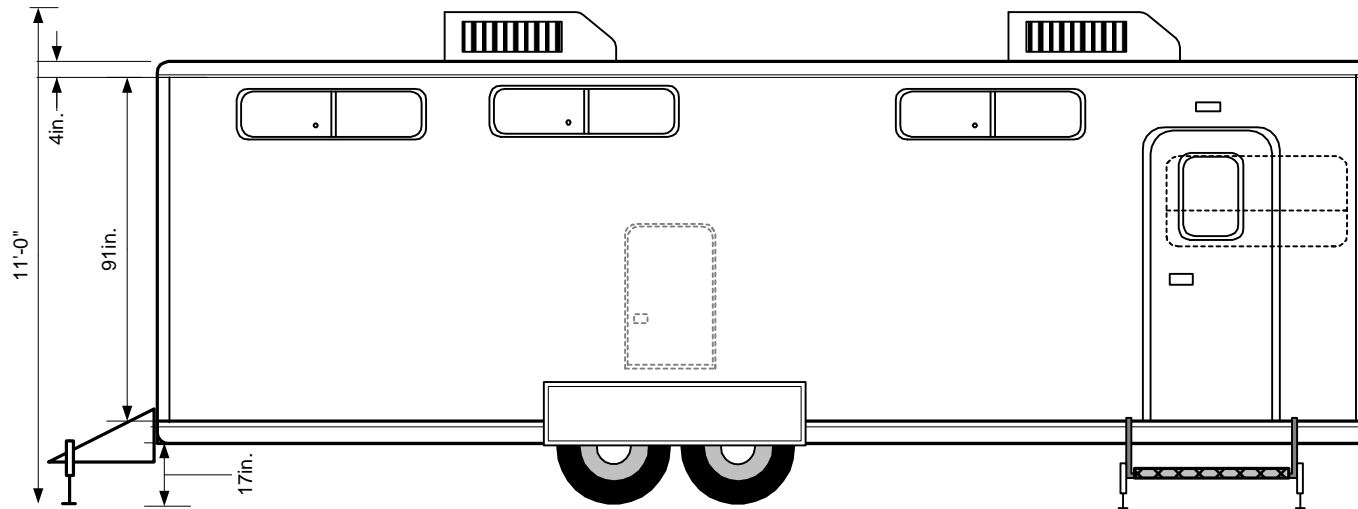

- 40 15x12x36 Locker s or 20 15x12x72
- 2 one step landings with Led porch lights
- Leveling jacks and five windows
- 2 7000 pound axles with electric brakes
- Air Conditioned 30,000 BTU heat 11000btu
- (1) 240 v @ 50 amp AC power required
- Heat on demand metered showers (2)
- All metal and composite construction no wood
- 1 Toilets 2 wall sinks
- Direct connect to sewer
- LED 50,000 hour burn lighting
- Radiused skylight doors and auto closers
- Retractable tounge & Low profile
- 3 benches

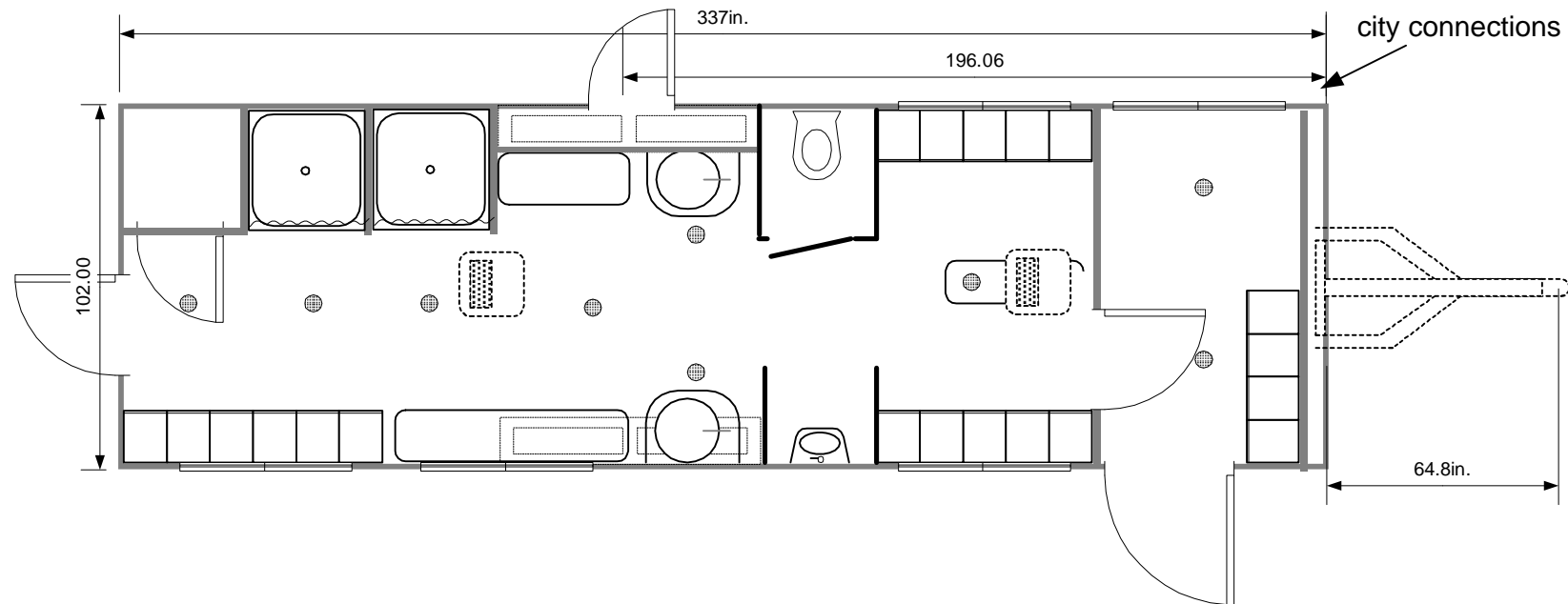

This document is the property of and contains unpublished proprietary information and trade secrets of A.M.S. Global Inc. By accepting possession of the document the recipient agrees to make no copies transcriptions or any use of this document or the information contained herein except as authorized by A.M.S. Global Inc. and further agrees to safe keep this document and return in to A.M.S. Global Inc. upon demand.

Approved by _____

www.AMSglobal.us (877) 789-1213 Copyright 2011 A.M.S. Global Inc. All rights reserved



25 9 144 9 334

Advanced Performance 28 2ST6S 20LC + Break

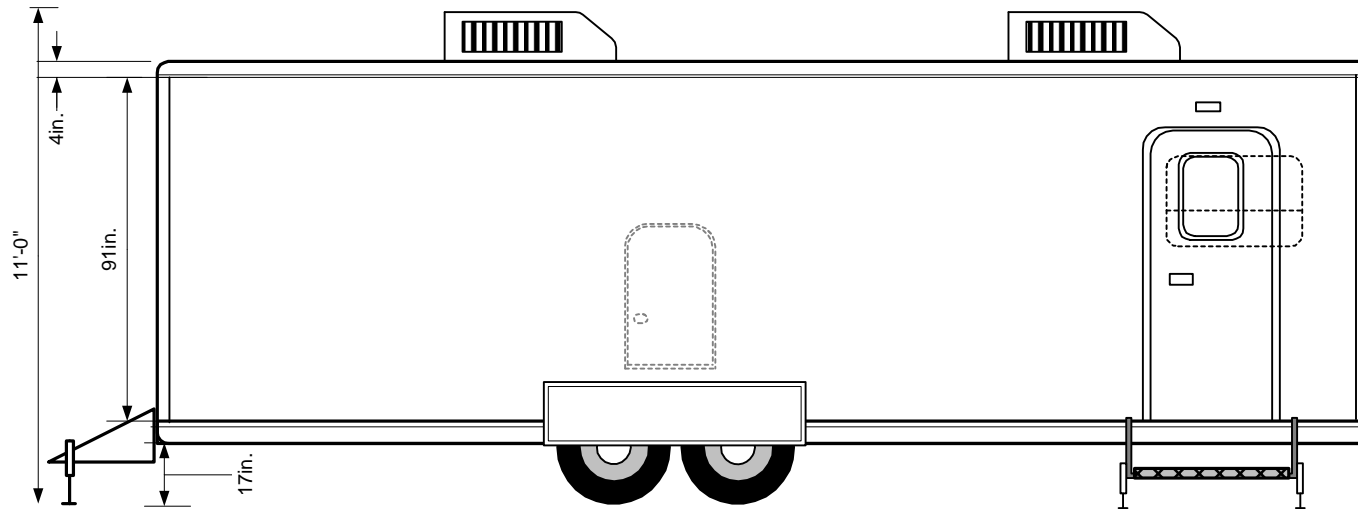

- 20 15x12x36 Lockers
- 2 one step landings with Led porch lights
- leveling jacks rear and one 2x3' window
- 2 electric 4000 pound front jacks
- 2 7000 pound axles with electric brakes
- Air Conditioned 30,000 BTU heat 11000btu
- 10 NT 12 volt VOD Jets Vacumerator Pump
- (1) 240 v @ 50 amp AC power required
- Heat on demand metered showers (6)
- All metal and composite construction no wood
- 2 Jets™ Marine Toilets Vacumerator™ 2 sinks
- Optima glass mat battery
- Direct connect to sewer
- Uses a pint of water per flush
- LED 50,000 hour burn lighting
- Radiused skylight doors and auto closers
- Liquefies all waste and paper
- Self Pumping to Sewer Tap over 100 feet
- Retractable tongue & Low profile
- Bar sink. cabinets & Skylight doors

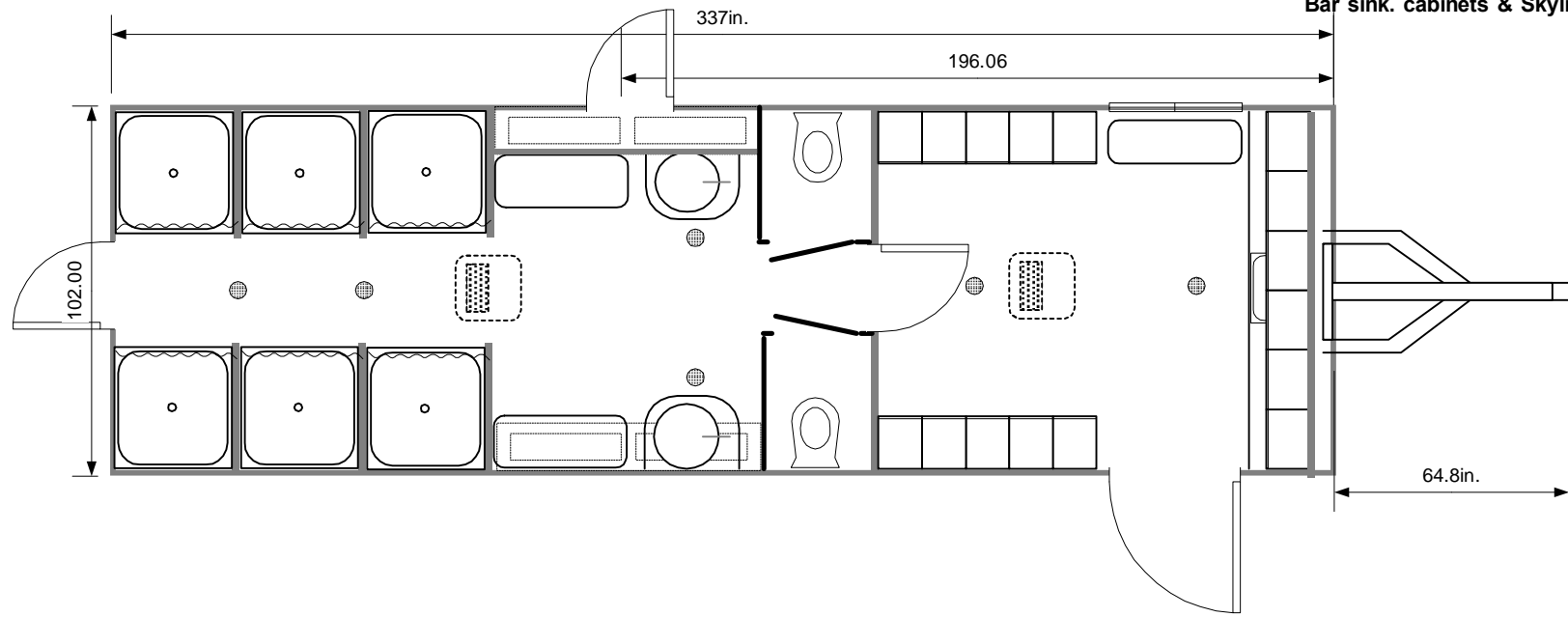

This document is the property of and contains unpublished proprietary information and trade secrets of A.M.S. Global Inc. By accepting possession of the document the recipient agrees to make no copies transcriptions or any use of this document or the information contained herein except as authorized by A.M.S. Global Inc. and further agrees to safe keep this document and return in to A.M.S. Global Inc. upon demand.

Approved by _____

www.AMSglobal.us (877) 789-1213 Copyright 2011 A.M.S. Global Inc. All rights reserved



370601690765

Advanced Performance 28 2STS 20LC

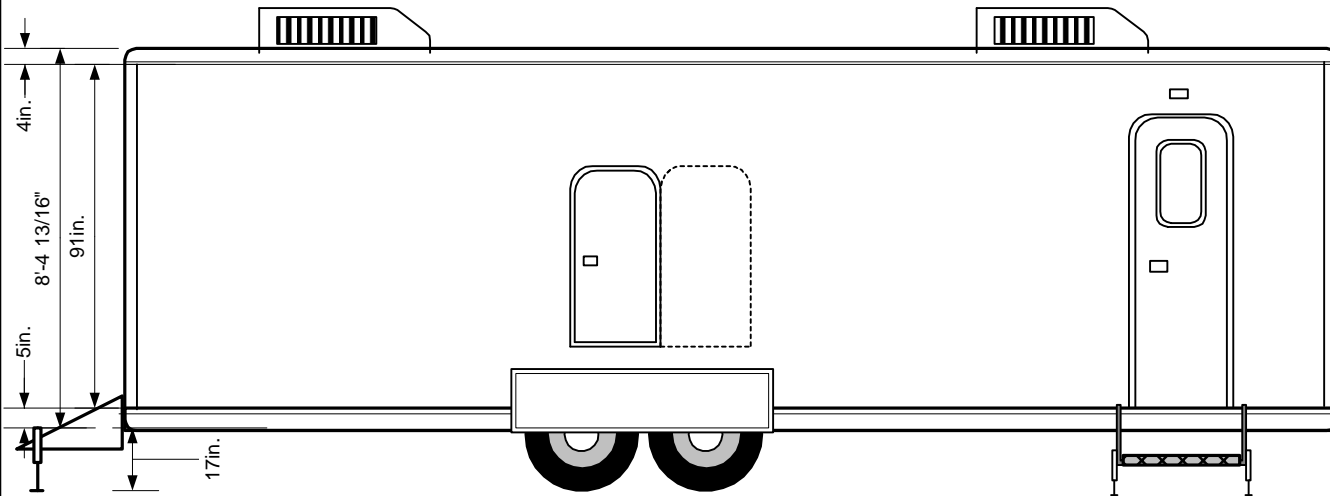

- 20 15x12x6 Zephyr Combination Lockers
- 10 NT Jets Vacuumator™ and 2 Jet s™ toilets
- 125 gallon rotationally molded waste tank (1000 flushes +)
- 3 one step landings & 2 rear leveling jacks
- 2 4000 L B electric Attwood front jacks
- 2 7000 pound axles with electric brakes
- Air Conditioned 30,000 BTU, heat 11000btu internal
- 6 1250 w Broan 154 ceiling heaters with thermostats
- 240 v @ 50 amp AC power required
- Heat on demand metered showers & faucets
- All metal and composite construction .040 alum. exterior
- 2 bath sinks Kitchen break area sink with cabinets
- LED 50,000 hour burn lighting
- Radiused skylight doors and auto closers 7 deadbolts
- 1.5" square tubing walls all composite and steel
- Radiant barrier double foil R15 rated
- Weblon insulated underpinning
- No wood & all electric
- Granitized tread steel floor
- Retractable tongue

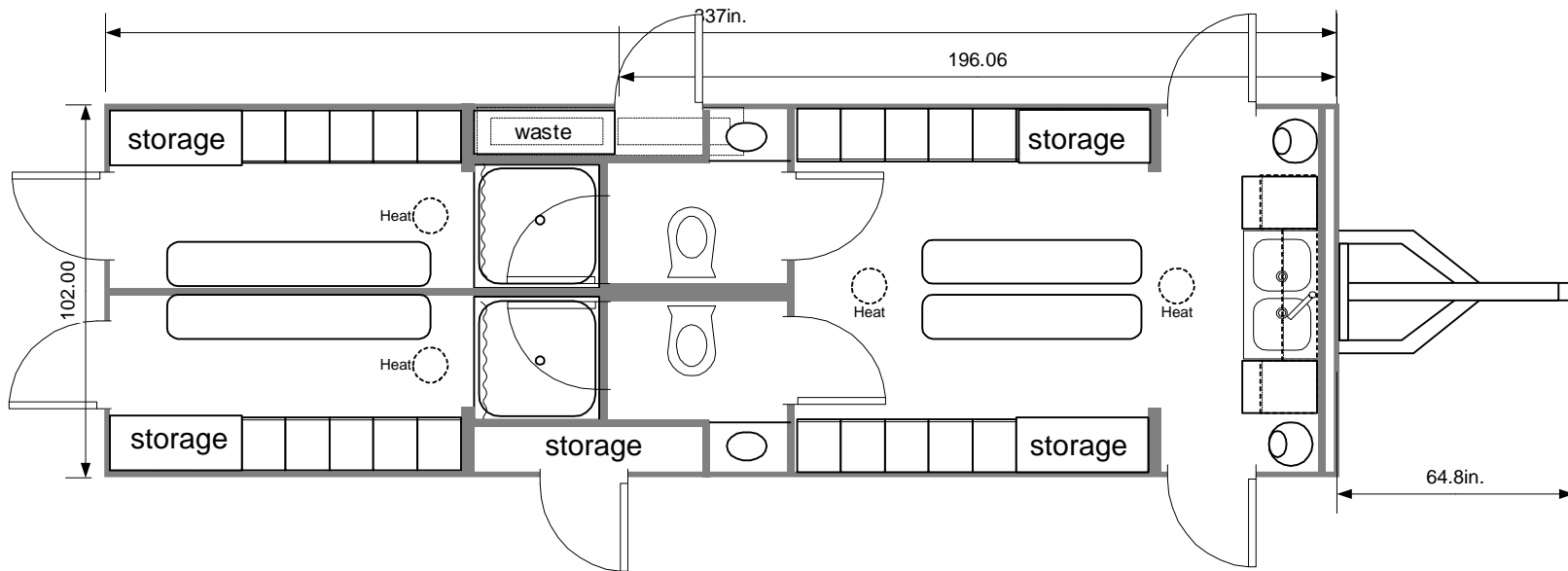

This document is the property of and contains unpublished proprietary information and trade secrets of A.M.S. Global Inc. By accepting possession of the document the recipient agrees to make no copies transcriptions or any use of this document or the information contained herein except as authorized by A.M.S. Global Inc. and further agrees to safe keep this document and return it to A.M.S. Global Inc. upon demand.

Approved by _____

www.AMSglobal.us (877) 789-1213 Copyright 2011 A.M.S. Global Inc. All rights reserved



450369890895

Advanced Performance 28 2STS 32LC + Break

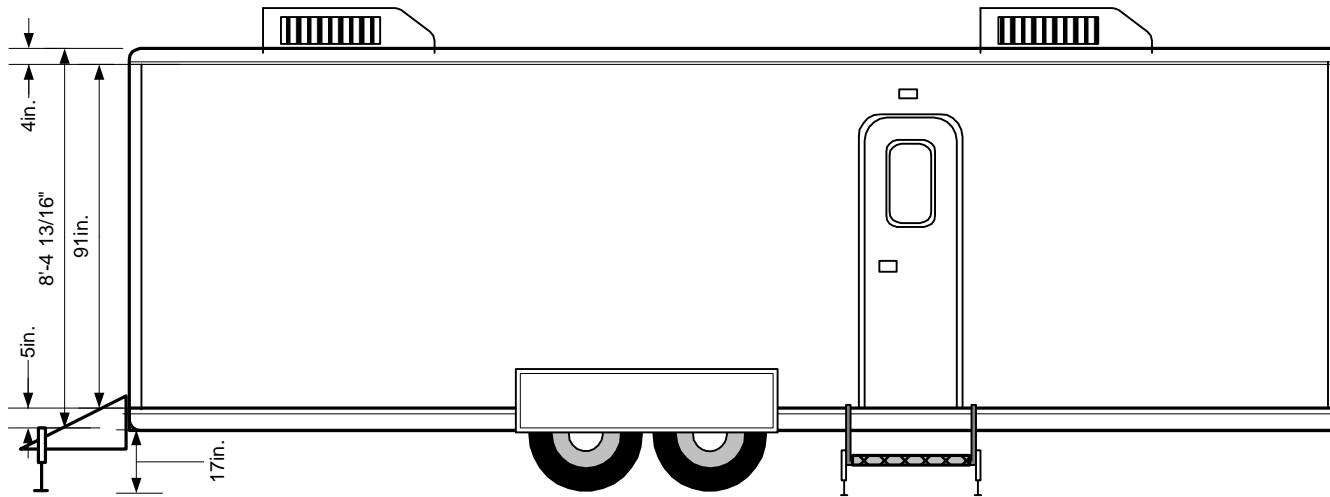

- 32 15x12x48 Lockers
- 3 one step landings
- leveling jacks
- 2 6000 pound axles with electric brakes
- Air Conditioned 30,000 BTU heat 11000
- 1MB 12 volt CVS Jets Vacumerator Pump
- (1) 240 v @ 50 amp AC power required
- Heat on demand metered showers & faucets
- All metal and composite construction
- 2 Jets Marine Vacumerator Toilets 2 wall sinks
- Optima glass mat battery
- Direct connect to sewer
- Uses a pint of water per flush
- LED 50,000 hour burn lighting
- Radiused skylight doors and auto closers
- Liquefies all waste and paper
- Self Pumping to Sewer Tap
- over 100 feet w/10' head
- Retractable tounge Kitchen sink & cabinets

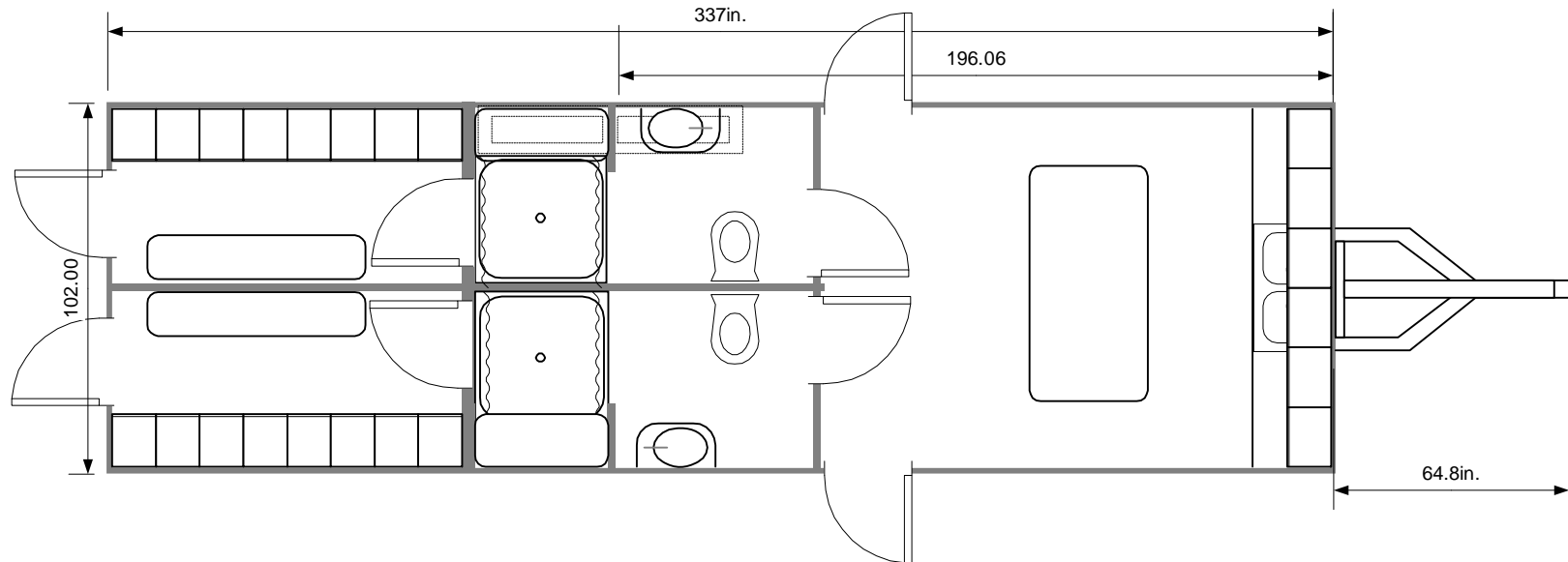

This document is the property of and contains unpublished proprietary information and trade secrets of A.M.S. Global Inc. By accepting possession of the document the recipient agrees to make no copies transcriptions or any use of this document or the information contained herein except as authorized by A.M.S. Global Inc. and further agrees to safe keep this document and return in to A.M.S. Global Inc. upon demand.

Approved by _____

www.AMSglobal.us (877) 789-1213 Copyright 2011 A.M.S. Global Inc. All rights reserved



450369890895

Advanced Performance 28 2STS 52LC

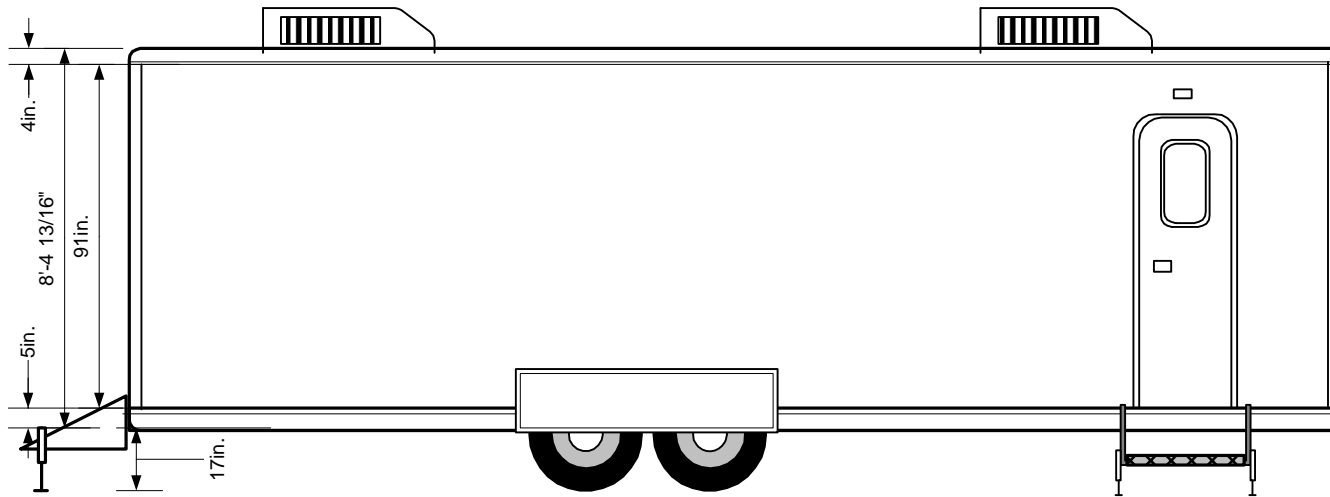

- 52 15x12x48 Lockers
- 3 one step landings
- leveling jacks
- 2 7000 pound axles with electric brakes
- Air Conditioned 30,000 BTU heat 11000
- 10MB 12 volt CVS Jets Vacuerator Pump
- (1) 240 v @ 50 amp AC power required
- Heat on demand metered showers & faucets
- All metal and composite construction
- 2 Jets Marine Vacuerator Toilets 2 wall sinks
- Optima glass mat battery
- Direct connect to sewer
- Uses a pint of water per flush
- LED 50,000 hour burn lighting
- Radiused skylight doors and auto closers
- Liquefies all waste and paper
- Self Pumping to Sewer Tap
- over 100 feet w/10' head
- Retractable tongue

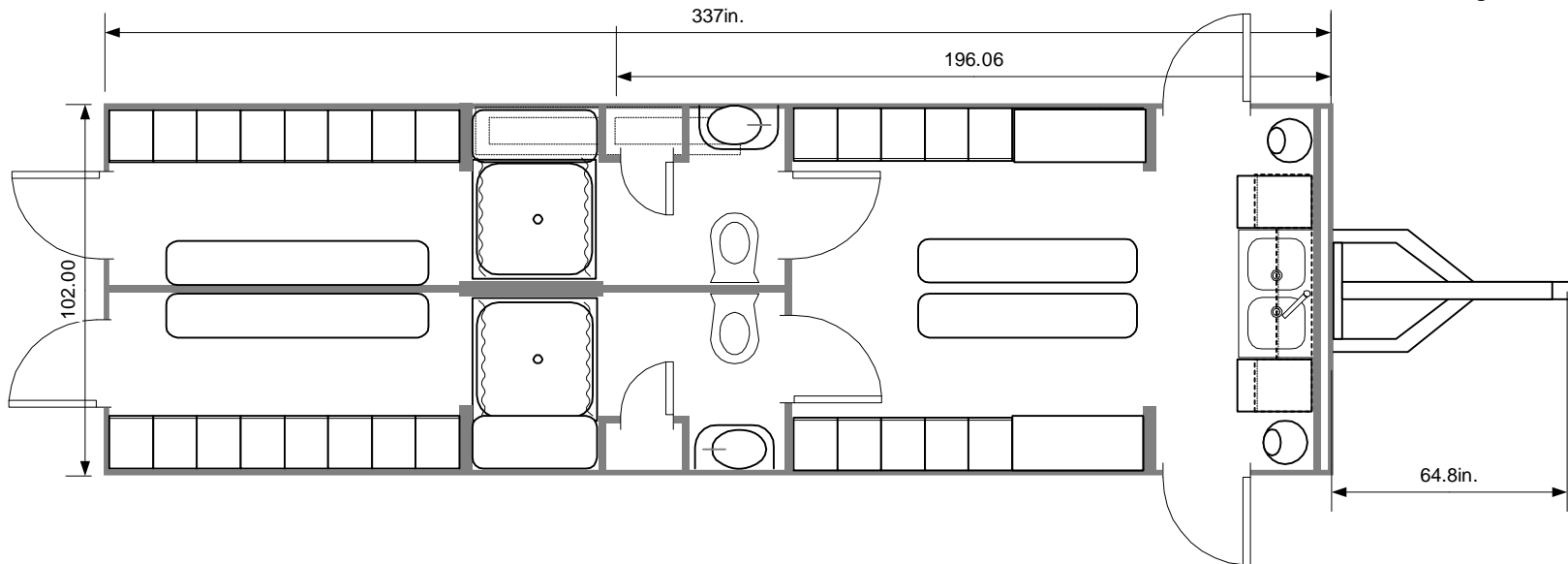

This document is the property of and contains unpublished proprietary information and trade secrets of A.M.S. Global Inc. By accepting possession of the document the recipient agrees to make no copies transcriptions or any use of this document or the information contained herein except as authorized by A.M.S. Global Inc. and further agrees to safe keep this document and return in to A.M.S. Global Inc. upon demand.

Approved by _____

www.AMSglobal.us (877) 789-1213 Copyright 2011 A.M.S. Global Inc. All rights reserved



450369890895

Advanced Performance 28 2STS 64LC

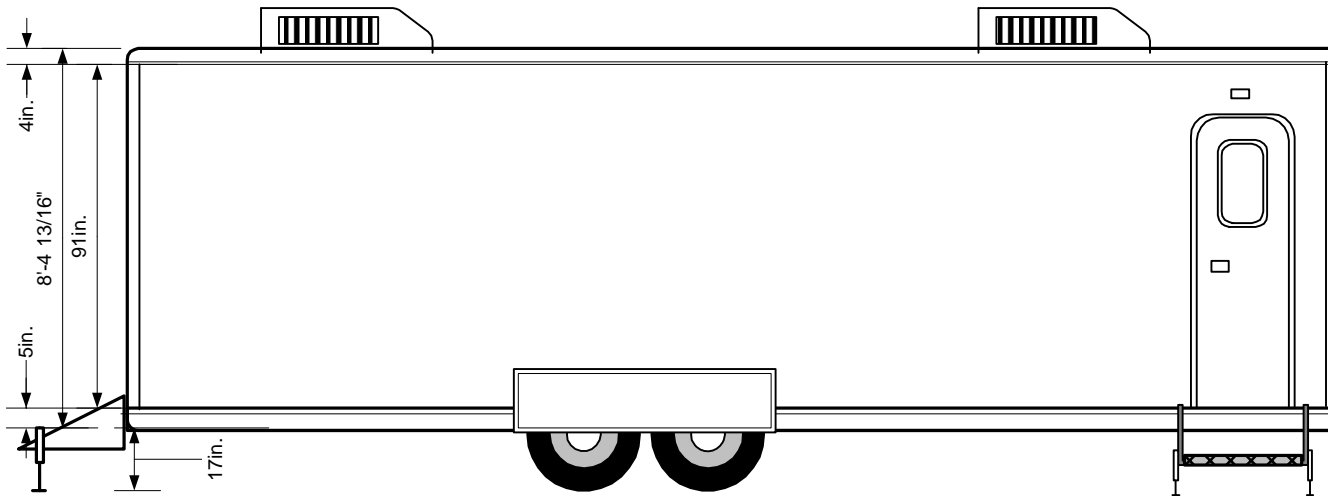

- 64 15x12x48 Lockers
- 3 one step landings
- leveling jacks
- 2 6000 pound axles with electric brakes
- Air Conditioned 30,000 BTU heat 11000
- 1MB 12 volt CVS Jets Vacuerator Pump
- (1) 240 v @ 50 amp AC power required
- Heat on demand metered showers & faucets
- All metal and composite construction
- 2 Jets Marine Vacuerator Toilets 2 wall sinks
- Optima glass mat battery
- Direct connect to sewer
- Uses a pint of water per flush
- LED 50,000 hour burn lighting
- Radiused skylight doors and auto closers
- Liquefies all waste and paper
- Self Pumping to Sewer Tap
- over 100 feet w/10' head
- Retractable tongue

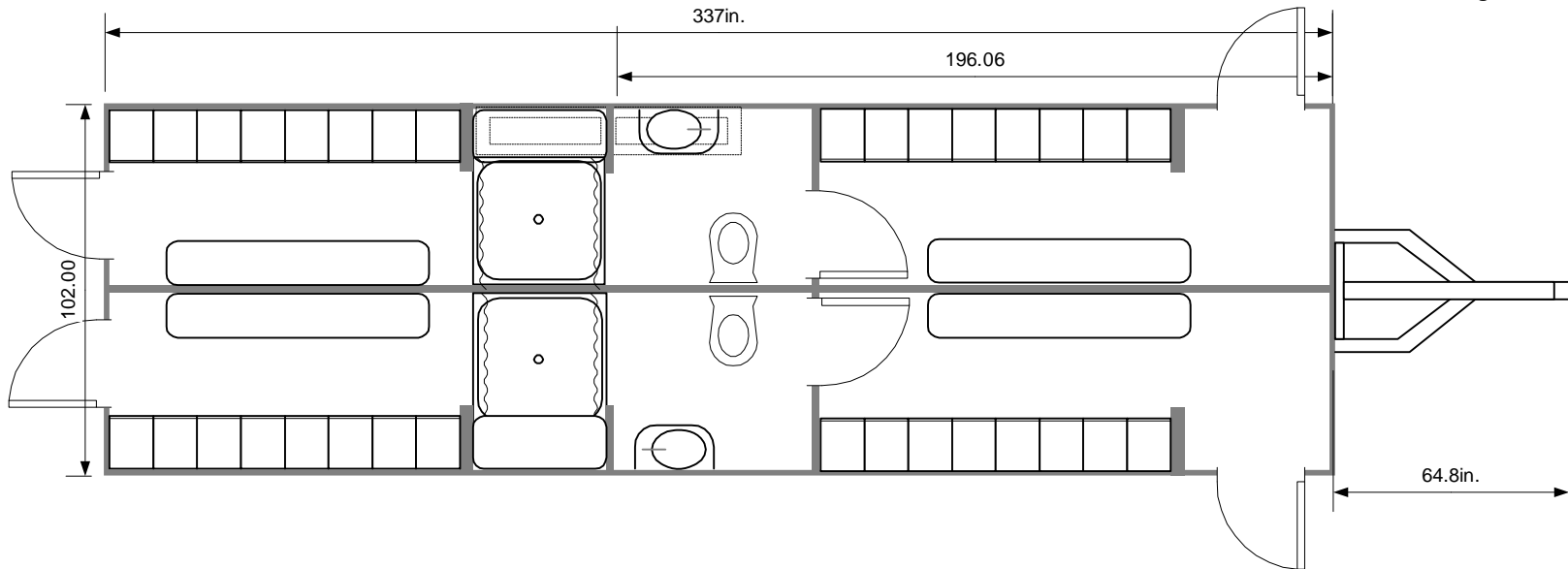

This document is the property of and contains unpublished proprietary information and trade secrets of A.M.S. Global Inc. By accepting possession of the document the recipient agrees to make no copies transcriptions or any use of this document or the information contained herein except as authorized by A.M.S. Global Inc. and further agrees to safe keep this document and return in to A.M.S. Global Inc. upon demand.

Approved by _____

www.AMSglobal.us (877) 789-1213 Copyright 2011 A.M.S. Global Inc. All rights reserved



250914490334

Advanced Performance 28 2TS 15SLC

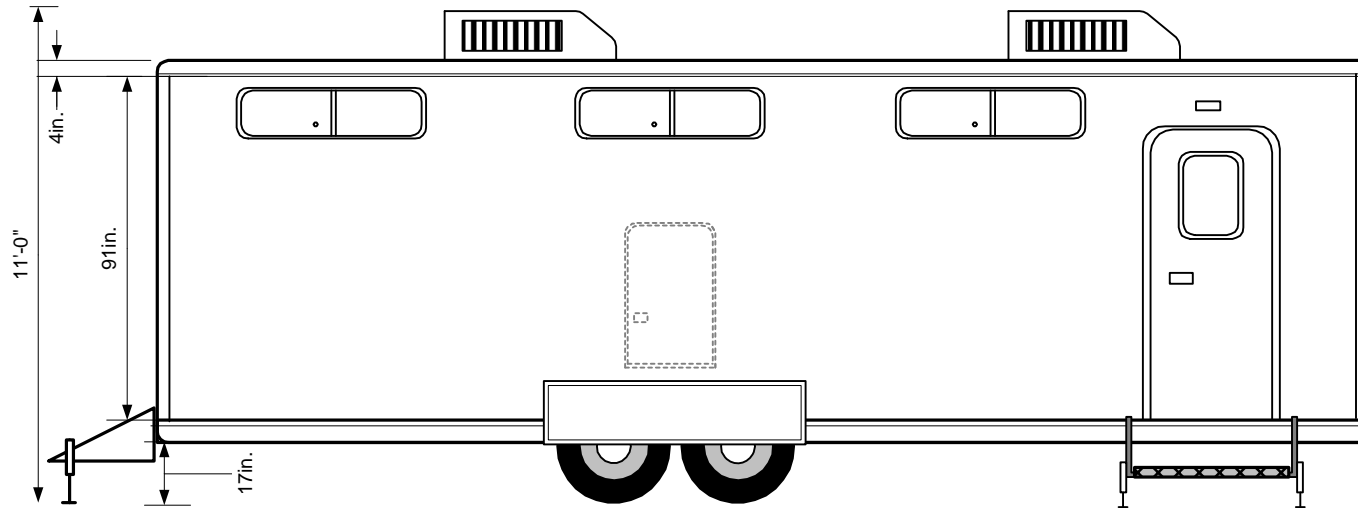

- 15 24x18x72 Lockers W/Footlocker seat
- 2 one step landings with Led porch lights
- Leveling jacks and 6 windows
- 2 7000 pound axles with electric brakes
- Air Conditioned 30,000 BTU heat 11000 btu
- (1) 240 v @ 50 amp AC power required
- Electric Heat on demand metered showers (2)
- All metal and composite construction no wood
- 2 Toilets 2 showers
- Direct connect to sewer
- LED 50,000 hour burn lighting
- Radiused skylight doors and auto closers
- Retractable tongue & Low profile

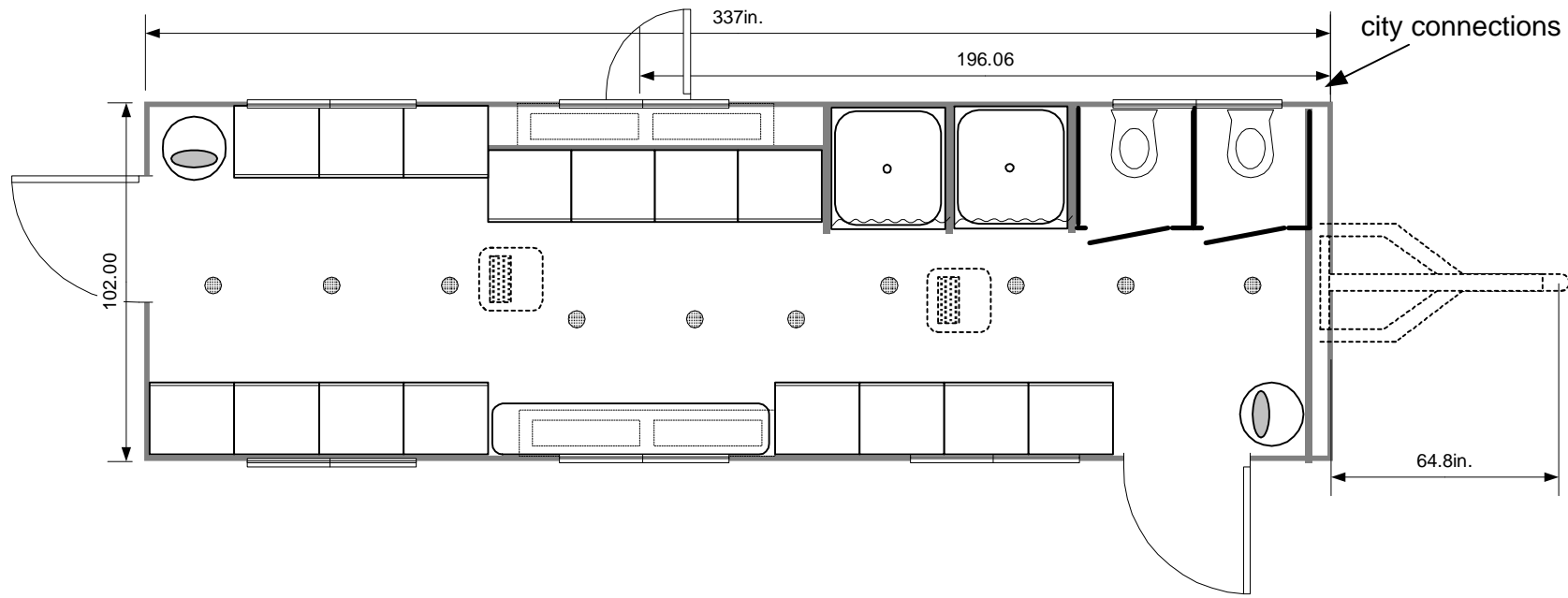

This document is the property of and contains unpublished proprietary information and trade secrets of A.M.S. Global Inc. By accepting possession of the document the recipient agrees to make no copies transcriptions or any use of this document or the information contained herein except as authorized by A.M.S. Global Inc. and further agrees to safe keep this document and return in to A.M.S. Global Inc. upon demand.

Approved by _____

www.AMSglobal.us (877) 789-1213 Copyright 2011 A.M.S. Global Inc. All rights reserved



250914490334

Advanced Performance 28 2S1T2S 20LC + Office Advanced Performance 24 2S1T2S 16LC

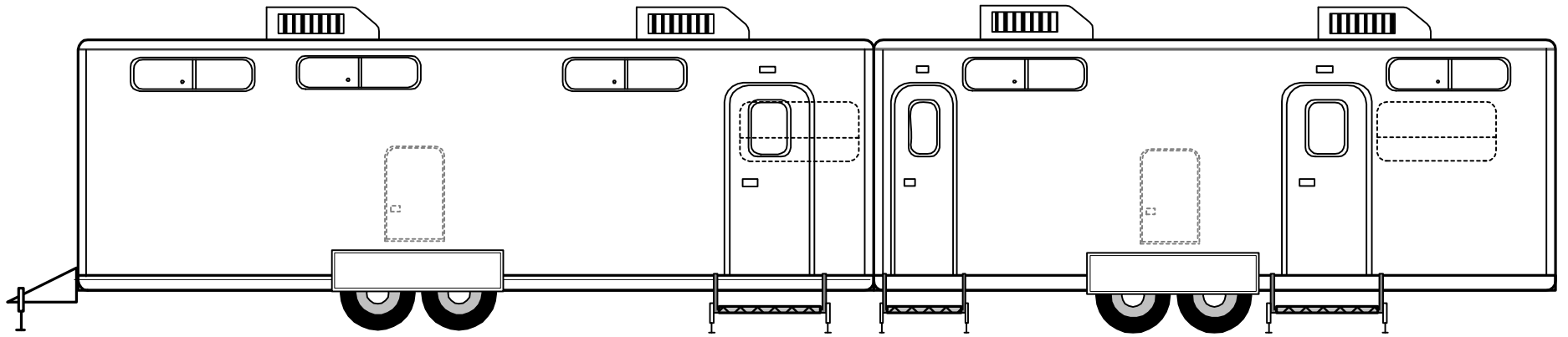

52'

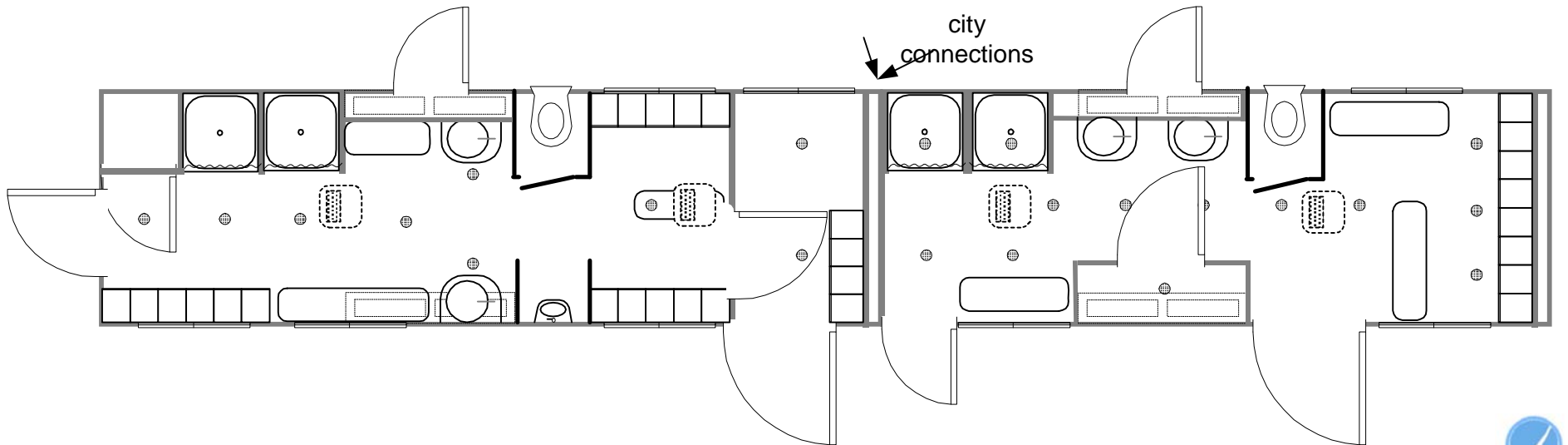

This document is the property of and contains unpublished proprietary information and trade secrets of A.M.S. Global Inc. By accepting possession of this document the recipient agrees to make no copies, transcriptions or any use of this document or the information contained herein except as authorized by A.M.S. Global Inc. and further agrees to safe keep this document and return it to A.M.S. Global Inc. upon demand.

Approved by _____

www.AMSglobal.us (877) 789-1213 Copyright 2011 A.M.S. Global Inc. All rights reserved



24 7 18 54 8 3 2

Advanced Performance 28 4S 20LC

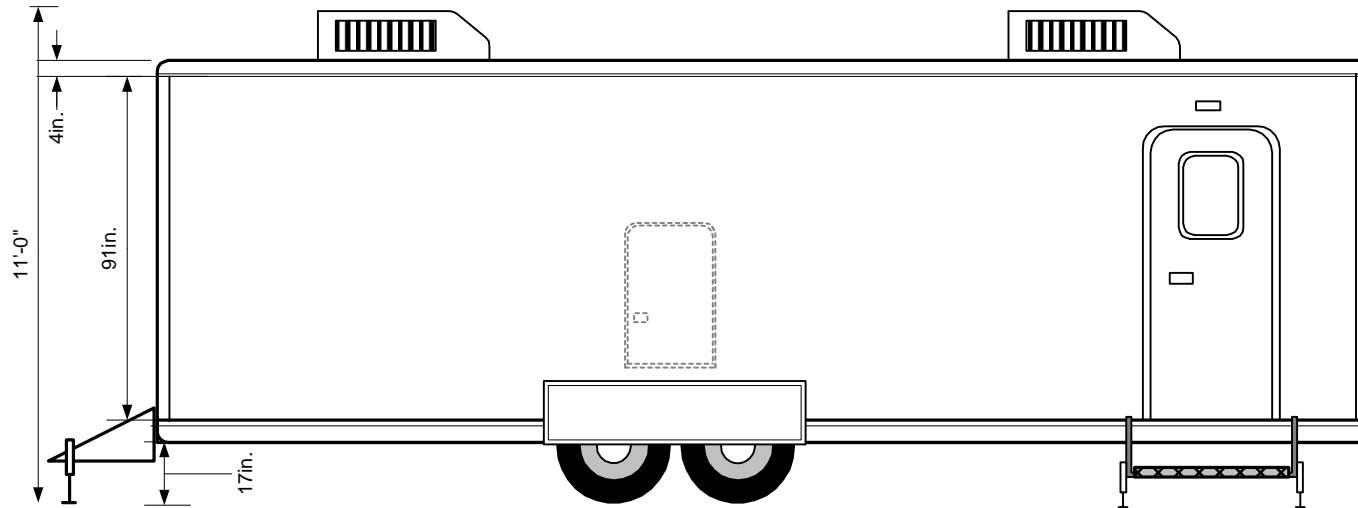

- 20 15x12x36 Lockers
- 2 one step landings with Led porch lights
- leveling jacks front & rear
- 2 7000 pound axles with electric brakes
- 2 15,000 BTU Air with 5500 btu heat each
- 4 powered vents
- 3 1200 watt ceiling heaters
- 240 v @ 245 amp vac power required hard wire
- Heat on demand metered showers (4)
- All metal and composite construction no wood
- Direct connect to sewer
- LED 50,000 hour burn lighting
- Radiused skylight doors and auto closers
- Retractable tongue & Low profile
- Bar sink. cabinets & Skylight doors
- 4 Benches and trash cabinet

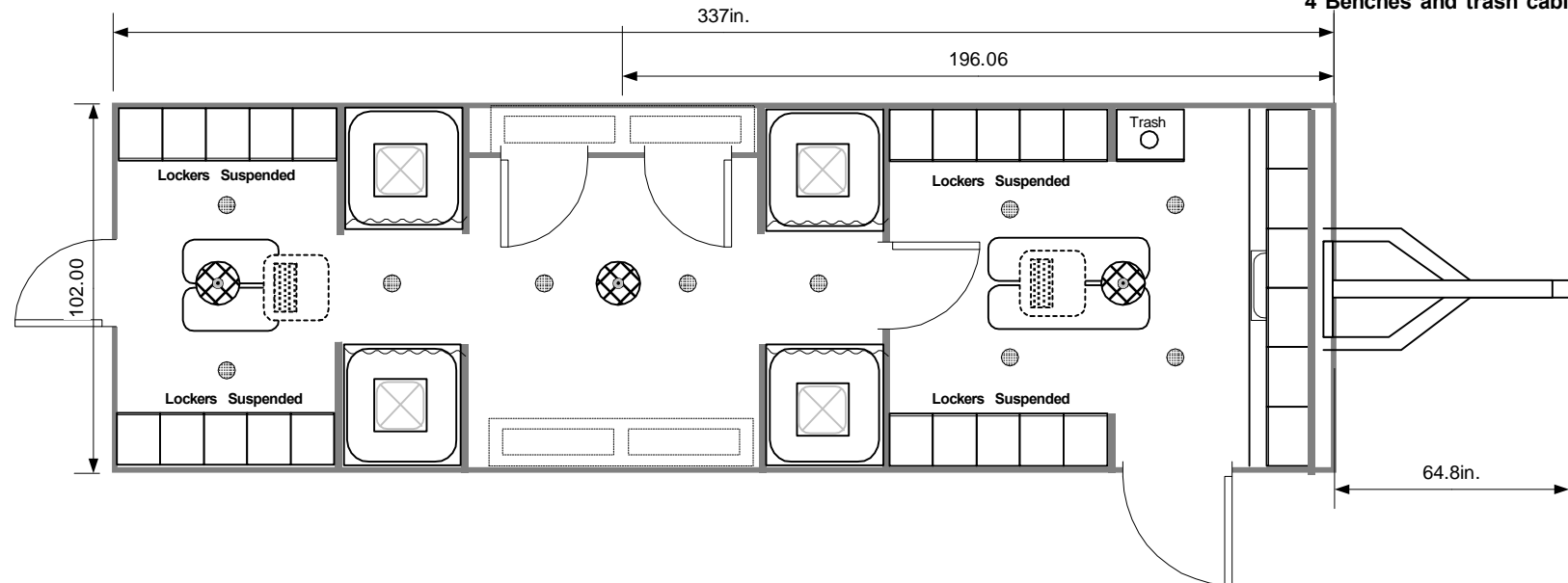

This document is the property of and contains unpublished proprietary information and trade secrets of A.M.S. Global Inc. By accepting possession of this document the recipient agrees to make no copies transcriptions or any use of this document or the information contained herein except as authorized by A.M.S. Global Inc. and further agrees to safe keep this document and return it to A.M.S. Global Inc. upon demand.

Approved by _____

www.AMSglobal.us (877) 789-1213 Copyright 2011 A.M.S. Global Inc. All rights reserved



450369890895

Advanced Performance 28 5STS 20LC

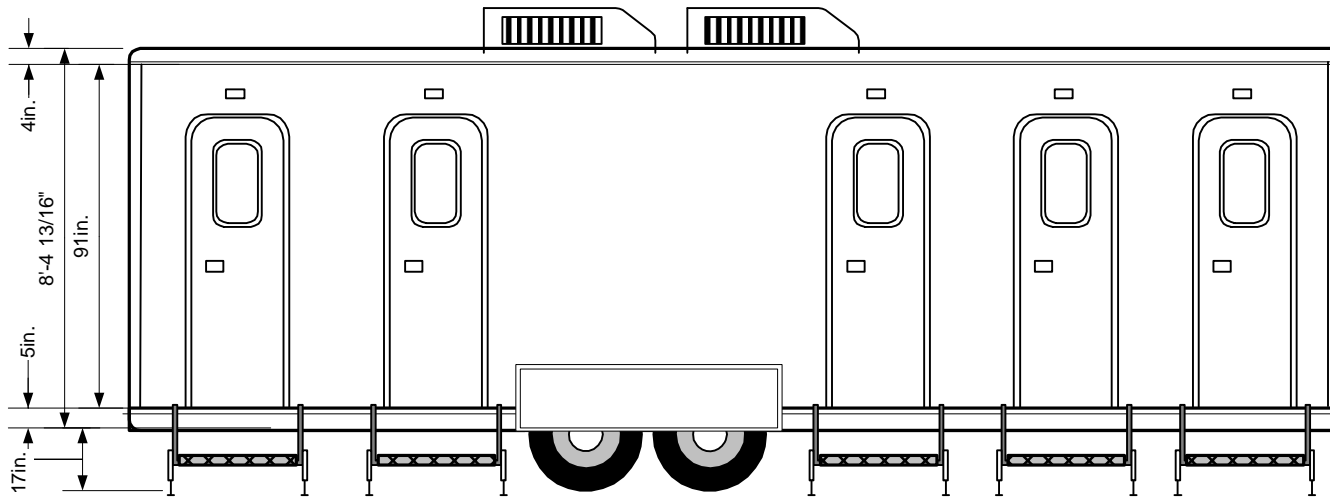

- 20 24x12x48 Lockers
- 5 one step landings
- 2 Remote controlled leveling jacks 16,000 lb
- 2 7000 pound axles with electric brakes
- Air Conditioned 30,000 BTU heat 11000
- 1MB 12 volt CVS Jets Vacumerator Pump
- (1) 240 v @ 50 amp AC power required
- Heat on demand metered showers & faucets
- All metal and composite construction
- 5 Jets™ Marine Toilets & Vacumerator™ 5 sink
- 2 Optima glass mat batteries
- 250 gallon waste tank capacity +- 2000 flushes
- 250 gallon fresh water storage
- Uses less than a quart per flush
- LED 50,000 hour burn lighting
- Radiused skylight doors and auto closers
- Liquefies all waste and paper
- Self Pumping to Sewer Tap
- over 100 feet w/10' head

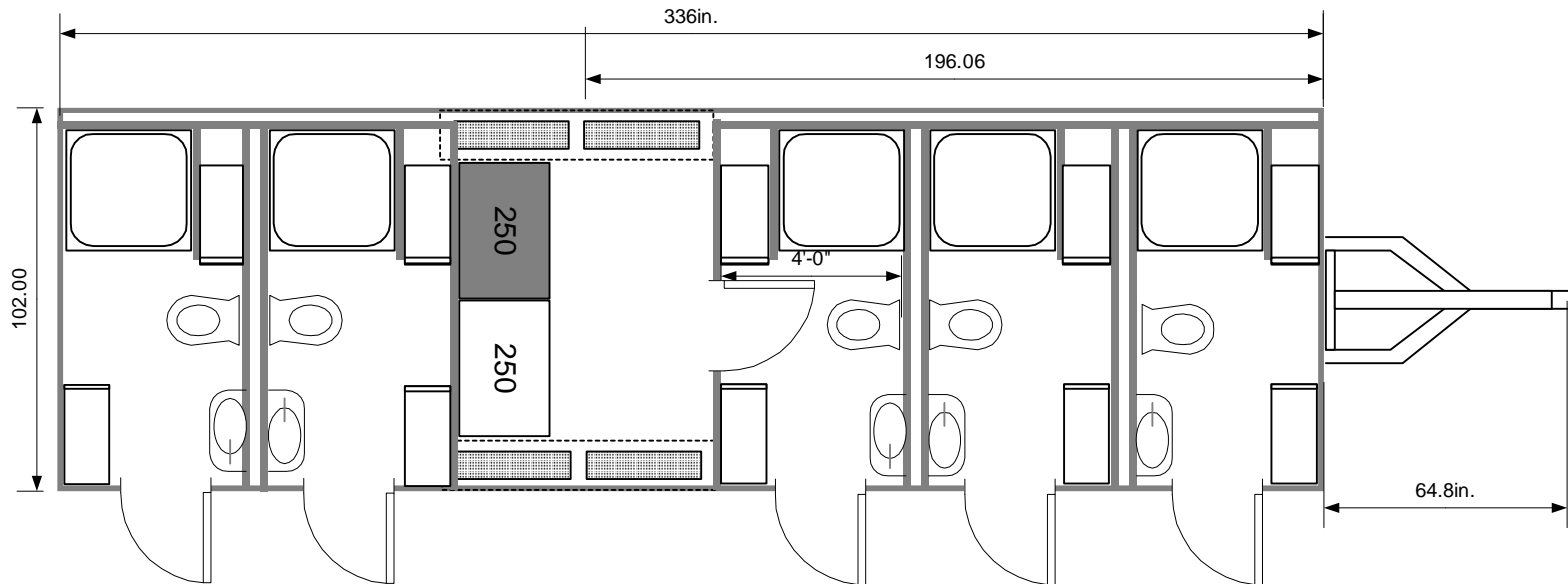

This document is the property of and contains unpublished proprietary information and trade secrets of A.M.S. Global Inc. By accepting possession of this document the recipient agrees to make no copies, transcriptions or any use of this document or the information contained herein except as authorized by A.M.S. Global Inc. and further agrees to safe keep this document and return it to A.M.S. Global Inc. upon demand.

Approved by _____

www.AMSglobal.us (877) 789-1213 Copyright 2011 A.M.S. Global Inc. All rights reserved



Advanced Performance 38 27 Tower

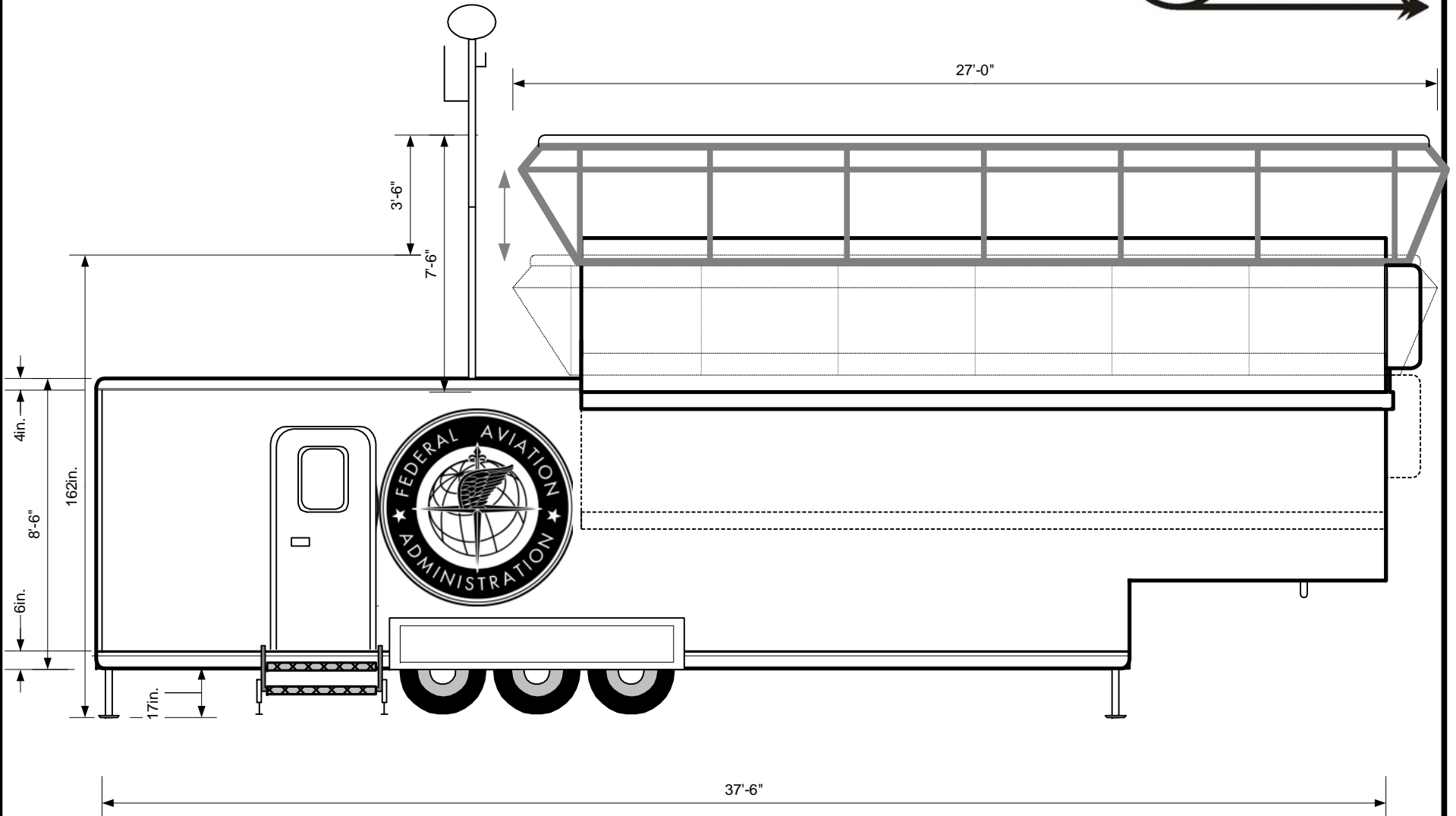

This document is the property of and contains unpublished proprietary information and trade secrets of A.M.S. Global Inc. By accepting possession of the document the recipient agrees to make no copies transcriptions or any use of this document or the information contained herein except as authorized by A.M.S. Global Inc. and further agrees to safe keep this document and return in to A.M.S. Global Inc. upon demand.

Approved by _____

